

u-Ring Redundancy Technology for Highly Reliable & Scalable Ethernet Applications

Overview

Along with the increasing needs on networking devices deployed in industrial applications such as automation, substations and transportation field, ensuring network availability and reliability has become one of the important issues that users and manufacturers alike concentrate on. To attain high network reliability, redundant links that are used to provide always-on connectivity are largely deployed. However, the drawbacks of deploying networking redundancy are too costly especially used in large-scale mesh-type topology and to create loops that downgrade the performance of the network. To overcome cost and loop issue, IEEE 802.1d spanning tree protocol (STP) and IEEE 802.1w Rapid Spanning Tree Protocol (RSTP) are implemented. Although STP and RSTP can be used in devices from differing vendors, slow convergence time and the limitation on the number of connected devices make both of them not an ideal option in demanding industrial grade applications. Having these considerations in mind, some vendors develop their own proprietary redundancy technology that intends to address the deployment issues most industrial users concern. Thus, in this white paper, a proprietary redundancy technology, u-Ring, developed by CTC Union is introduced. In the following sections, we will start from introducing redundancy mechanisms used in practice and then providing benefits of u-Ring redundancy technology. Next, the types of u-Ring redundancy technology and how u-Ring redundancy technology works will be elaborated with basic and advanced application samples. Then, the descriptions and results of recovery time performance test will be provided. In conclusion, this paper summarizes main features of u-Ring redundancy technology.

1. Network Redundancy Mechanisms

Network redundancy is used to prevent a point of fail from interrupting the services of the whole network. It is highly required especially for industrial applications that need to provide always-on services. Nowadays, several redundancy mechanisms are used in practice to enhance network availability ranging from common and standard-based protocols to proprietary redundancy protocols. In this section, network redundancy mechanisms will be introduced in sequence.

- **Mesh-type redundancy mechanism**

In mesh-type redundancy mechanism, each participating device is connected to other devices so as to provide several redundant links for critical data. In the event of a link failure, data can travel alternative path to the destination. However, using mesh-type redundancy topology may generate loops that eventually downgrade the performance of the network. The other problem with the mesh-type redundancy mechanism is to spend more money on cable wiring. For a small-scale deployment, the operation and maintenance cost may be acceptable. However, in a large-scale deployment with 1000 devices or more, the operation and maintenance cost may be extremely costly.

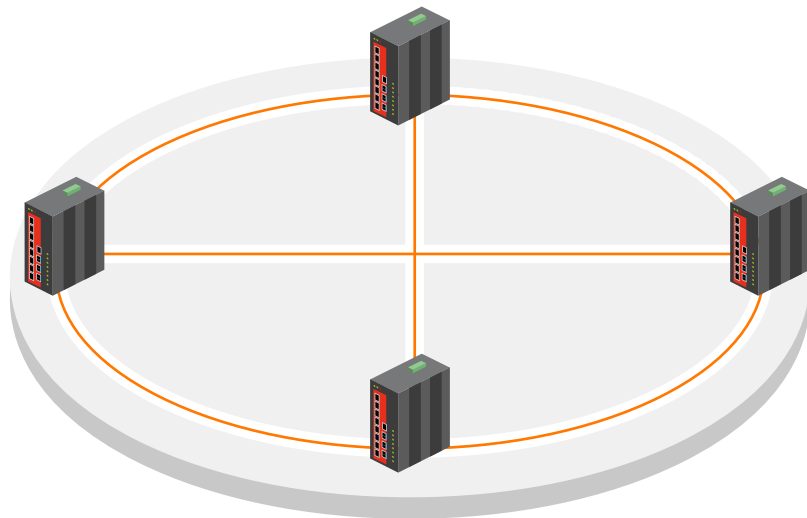

Figure 1. Mesh-type redundancy mechanism

• **Spanning tree protocol (STP, RSTP)**

The main purpose of redundant links is to provide an alternative path for delivering data when a point of fail occurs. However, if they are not dealt with carefully, loops will be created on the network. To avoid loops, IEEE introduced 802.1d STP (Spanning Tree Protocol) and 802.1w RSTP (Rapid Spanning Tree Protocol) standard to block a backup path from transmitting data based on Spanning Tree Algorithm so as to provide loop-free networking environments.

As shown in Figure 2, the network using STP blocks the backup path from transmitting data. All data and packets are transmitted via solid (active) lines until a faulty link occurs.

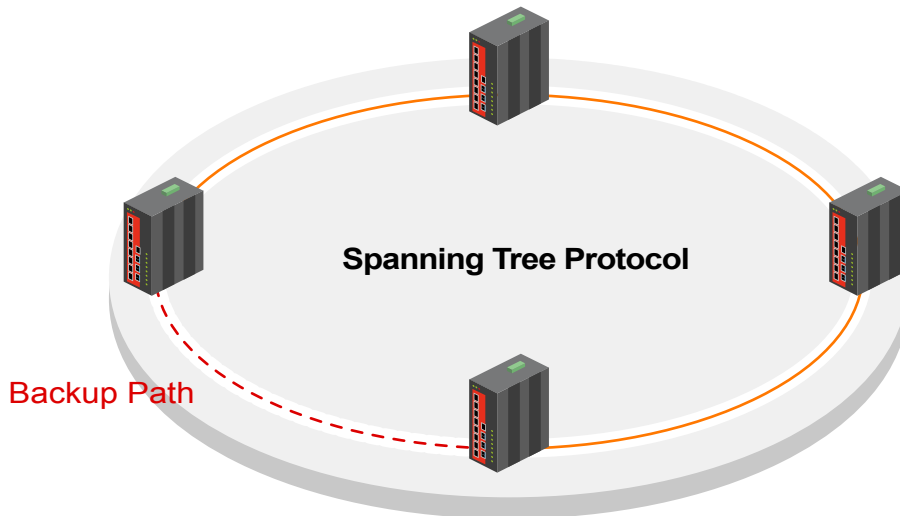

Figure 2. Ring topology using STP

Once a disconnected link is detected, STP brings the backup path back into active status. See Figure 3 for example.

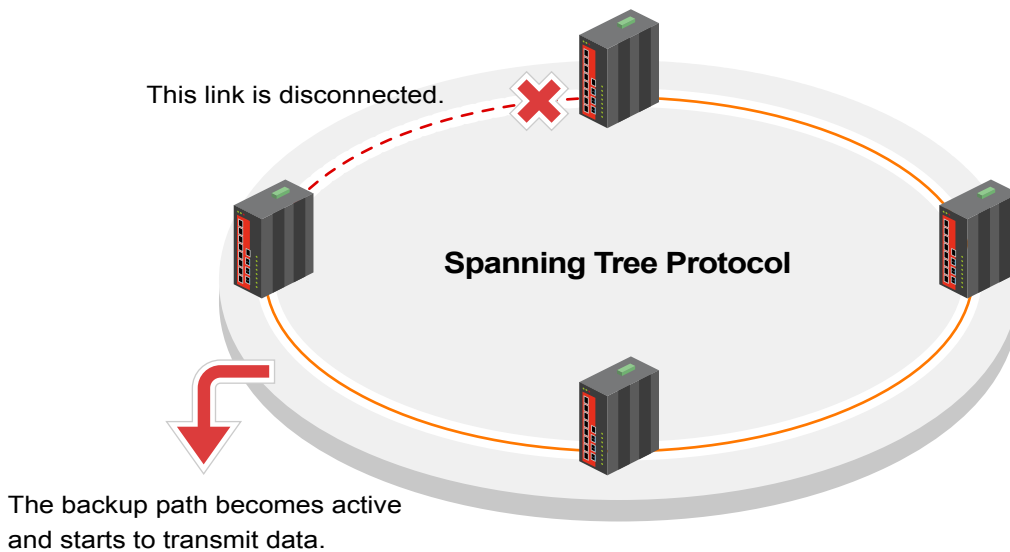

Figure 3. The backup path becomes active

Apart from avoiding loops on the network, STP is capable of supporting devices from different vendors in the same network as long as they all support STP. However, in terms of the recovery time after a failure, STP and RSTP have longer recovery time compared with most proprietary redundancy protocols which are not acceptable for mission-critical industrial applications.

• **Proprietary ring-type redundancy protocol**

For industrial applications, the failure recovery time is extremely critical to network quality and reliability. Spanning tree protocol and Rapid spanning tree protocol have the recovery time up to 30 seconds and 5 seconds, respectively, which make them unacceptable to demanding industrial applications. Thus, some vendors develop their own proprietary redundancy protocol to improve the failure recovery time.

Among various proprietary redundancy protocols, u-Ring is one of the cost-effective solutions that supports flexible and scalable network topologies and has relatively shorter failure recovery time than any other spanning tree protocols. Other benefits of u-Ring are described in the following section 2.

2. Proprietary u-Ring Redundancy Protocol

u-Ring is a proprietary redundancy protocol developed by CTC Union that supports flexible networking topologies and provides faster recovery time when a point of failure occurs on the network. Compared with IEEE standard redundancy protocols, u-Ring outperforms these standard protocols with the following benefits.

• **Supporting 5 instances and up to 250 devices in a ring to achieve scalable network infrastructure**

The maximum number of devices allowed in a u-Ring supported ring is 250. Unlike STP and RSTP that consider all LAN devices in a shared STP or RSTP system, each device with u-Ring redundancy protocol can support up to 5 instances (See Figure 4) in separate redundant rings that operate independently of other rings. In this way, users have more freedom to structure or expand their networking environments into various rings depending on their actual applications and needs.

The screenshot shows the 'u-Ring Configuration' web interface. At the top right, there are 'Auto-refresh' and 'Refresh' buttons. Below is a table with the following structure:

Delete	Instance	Type	Master	East		West	
				Port	Edge	Port	Edge
Delete	1	u-Ring	<input type="checkbox"/>	1		2	
Delete	2	u-Ring	<input type="checkbox"/>	4		3	
Delete	3	u-Ring	<input type="checkbox"/>	10 (Fiber2)		11 (Fiber3)	
Delete	4	Sub-Ring	<input type="checkbox"/>	6			
Delete	5	u-Chain	<input type="checkbox"/>	5	<input type="checkbox"/>	9 (Fiber1)	<input type="checkbox"/>

Below the table are buttons for 'Add New Instance', 'Save', and 'Reset'.

Figure 4. An illustration of u-Ring instances configured in Web interface

• Recovering from a link failure in 10 milliseconds

The failure recovery time is the time that a switch takes to bring the faulty network back into normal services after a network failure occurs. Generally speaking, IEEE STP and RSTP take up to 30 seconds and 5 seconds respectively to recover from a network fault. However, for most industrial applications such as IP surveillance devices, long failure recovery time is not acceptable since the longer the recovery time is the more packet loss it has.

On the other hand, u-Ring redundancy protocol is designed to rapidly adjust to the network change and it guarantees 10 milliseconds (henceforth 'ms') recovery time to reduce the possibility of packet loss and provide the highest transmission quality for all connected services.

• Providing ring, chain and Sub-Ring configuration types

Unlike typical ring-type redundancy protocols from other vendors that merely support closed rings, u-Ring redundancy protocol can support both closed and open rings. To do that, three u-Ring types, namely u-Ring type, u-Chain type, Sub-Ring type, are designed to provide enhanced flexibility. When configuring a closed ring, u-Ring type must be selected; whereas, when configuring an open ring, either u-Chain or Sub-Ring type can be selected. In addition to that, u-Chain type can also work with third-party devices that do not support u-Ring redundancy protocol.

The purpose of providing three u-Ring types is to provide users more freedom to establish any kinds of network topologies, no matter how simple or complex they are. u-Ring redundancy protocol is capable of supporting this kind of flexibility and scalability to help users plan and expand their network into a way they want.

• Simple setup procedures

Compared with IEEE spanning tree standards, u-Ring redundancy protocol is easy to set up simply by selecting the appropriate options from the pull-down menu in Web interface. Similar to STP and RSTP, u-Ring first decides a Master (a root bridge in STP and RSTP) and then determines the backup path.

u-Ring redundancy protocol allows users to manually select the Master. If the Master is not selected manually, then u-Ring redundancy protocol automatically selects a Master device in a ring and blocks a port accordingly. Once users incorrectly select two Masters in a ring, the u-Ring redundancy protocol can ignore this wrong setting and reconfigure a Master for the ring to avoid malfunctions in the ring.

• Monitoring ring status easily via Web interface and SmartView Management System

While operating u-Ring redundancy protocol in a ring, the port type, Master information, port status (forwarding or blocking) can be viewed in Web interface. If users manage devices via SmartView, u-Ring status and a point of fail can be viewed via SmartView as well in a visualized manner so as to help networking engineers deal with network broken link promptly and efficiently.

Instance	Type	Role	East Port			West Port			Healthy
			Number	State	Edge	Number	State	Edge	
1	u-Ring	Master	1	Down	---	2	Down	---	●
2	u-Ring	Master	4	Blocking	---	3	Forwarding	---	●
3	u-Ring		10 (Fiber2)	Down	---	11 (Fiber3)	Down	---	✗
4	Sub-Ring		6	Down	---	---	---	---	✗
5	u-Chain		5	Forwarding		9 (Fiber1)	Down	✓	✗

Figure 5. An illustration of u-Ring status in Web interface

- : The ring with a redundant path works normally.
- : One of the forwarding paths in the ring is down. The status of backup path is changed from "blocking" to "forwarding".
- ✗ : There is no physical link.

3. u-Ring Types and Operations

One of the increased flexibilities that u-Ring redundancy protocol has is to support both open and closed rings. To make this feature work, three u-Ring types have been developed that are intended to be used in various topologies ranging from basic to complex ones. In this section, we will introduce these three ring types, namely u-Ring, u-Chain, and Sub-Ring type one by one. Then, we move on to explain how the backup path is determined and how u-Ring redundancy actually works when a fault in a ring occurs.

• u-Ring type

u-Ring type is used in a closed ring topology and can be used together with u-Chain or Sub-Ring type to form a more complex topology. In a closed ring topology, the maximum number of devices supported is 250. Users can manually assign one switch as the Master. If users do not manually assign a switch as the Master or incorrectly assign more than one switch as the Master, then u-Ring redundancy protocol will automatically select or re-select the Master in a ring based on MAC address of each participating devices. u-Ring redundancy protocol selects the switch with biggest MAC address as the Master. Once the Master device is determined, the port in the Master with the highest port number will be automatically blocked and temporarily act as the backup path. The Figure 6 shows the selection of backup path depending on MAC addresses and port numbers. Please note that the participating devices that are not selected as the Master are in Slave roles.

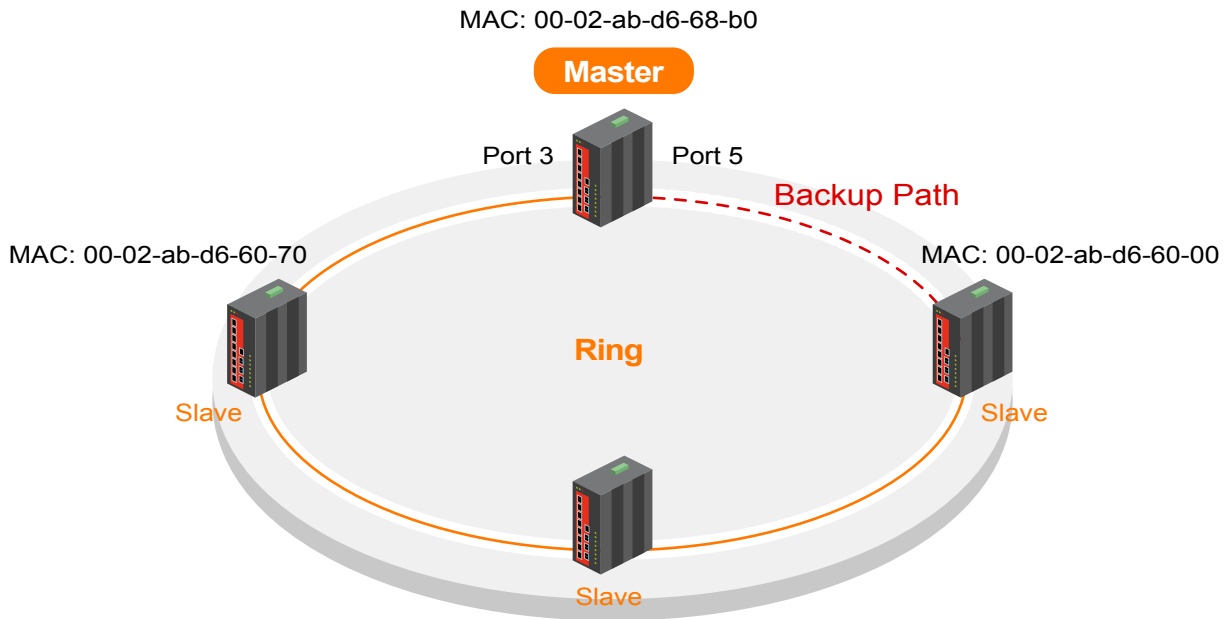

Figure 6. Determining the backup path (u-Ring type)

Once a link in the ring is disconnected, the backup path will become active instantly in 10ms in a ring to transmit and receive data so as to ensure continuous connectivity. On the other hand, the broken link will now act as the backup path until the problem of faulty link is solved. Figure 7 illustrates the change of backup path when a link is down.

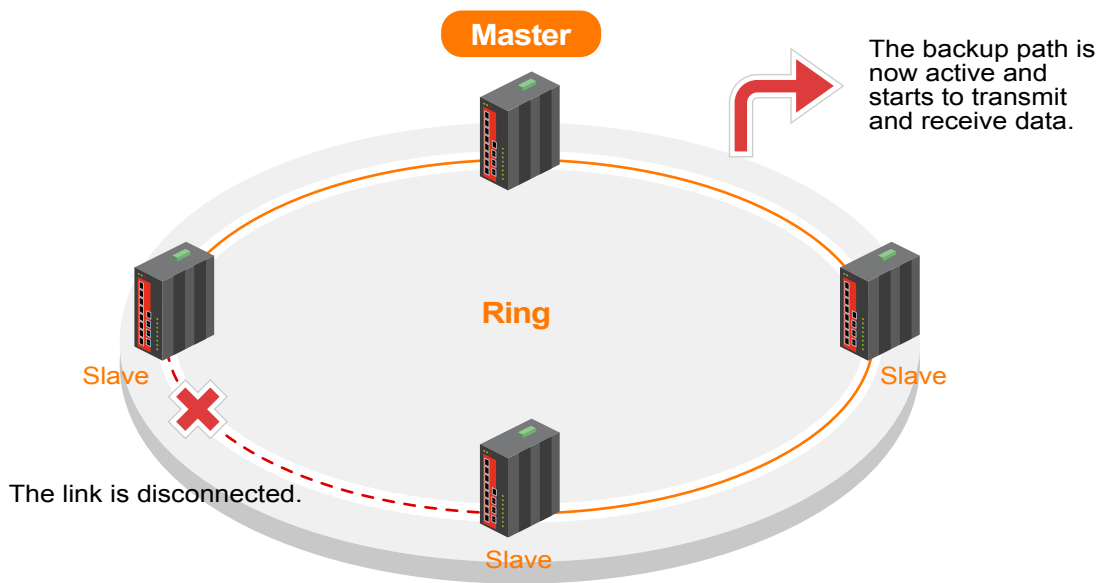

Figure 7. The change of backup path when a link is disconnected in a ring (u-Ring type)

• u-Chain type

The proprietary u-Ring redundancy protocol is able to work with (third-party) devices that do not support u-Ring redundancy protocol. However, when using (third-party) non-u-Ring supported devices to establish a bigger redundant network with u-Ring supported devices, there are several conditions that require close attention.

1. Third-party devices must already be running a redundant network protocol such as STP or RSTP.
2. When u-Ring network has a topology change, third-party devices must be able to receive Topology Change Notification (TCN) BPDUs from the u-Ring devices and flush their CAM (Content Addressable Memory) table so as to re-learn MAC addresses.
3. u-Ring supported edge devices must use u-Chain type to establish redundant networks with third-party STP or RSTP networks.

In a ring topology using u-Chain type, the maximum number of u-Ring supported devices is 250. Figure 8 depicts an open u-ring topology with switches supporting u-Ring redundancy protocol and devices in a STP/RSTP redundant network that do not support u-Ring redundancy protocol. The ports connecting to devices that do not support u-Ring redundancy protocol must be u-chain edge ports. The switches with u-chain edge ports are eligible to be selected as a Master. Users can manually select the desired Master or let the u-Ring redundancy protocol select the Master automatically based on MAC address of the devices with edge ports. The highest MAC address will determine the Master. Once the Master is determined, the edge port is blocked and acts as the temporary backup path until a fault is detected in the ring. Please note that the participating devices that are not selected as the Master are all in Slave roles.

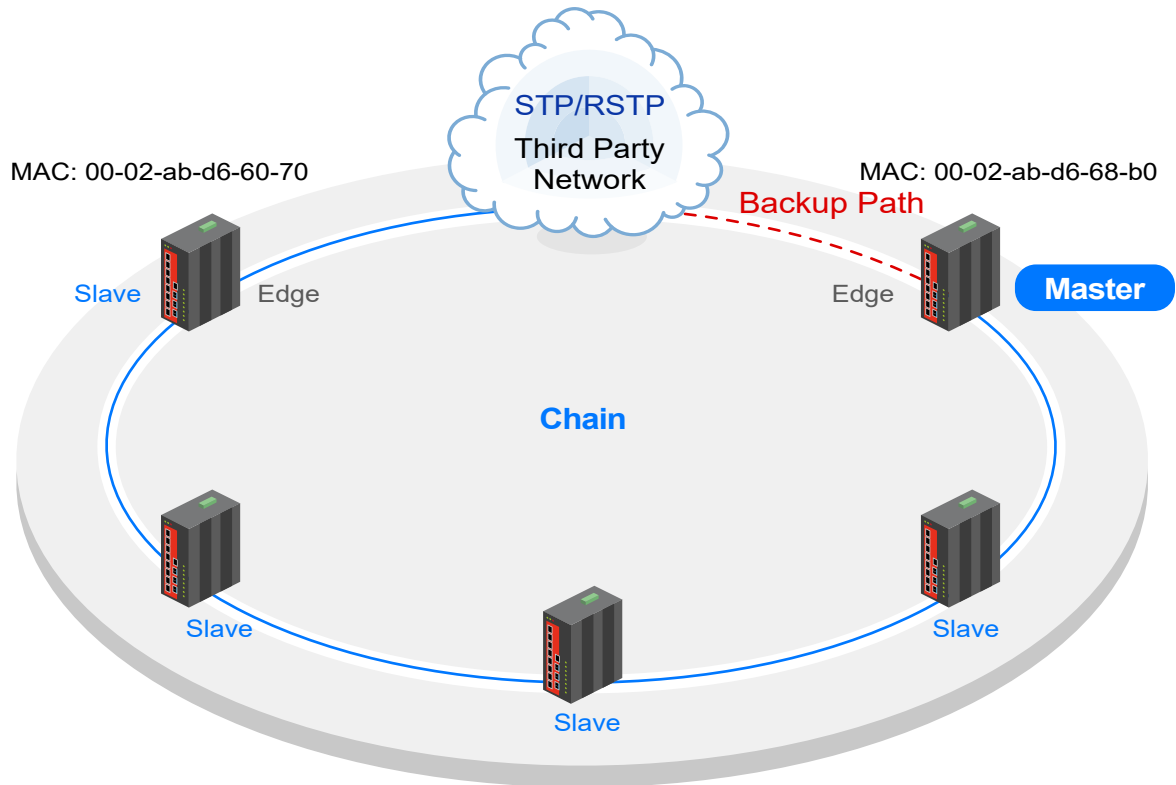

Figure 8. Determining the backup path (u-Chain type)

Once a link in the ring is disconnected, the backup path will become active instantly in 10ms in a ring to transmit and receive data so as to ensure continuous connectivity. On the other hand, the broken link will now act as the backup path until the problem of faulty link is solved. Figure 9 below illustrates the change of backup path when a link is disconnected.

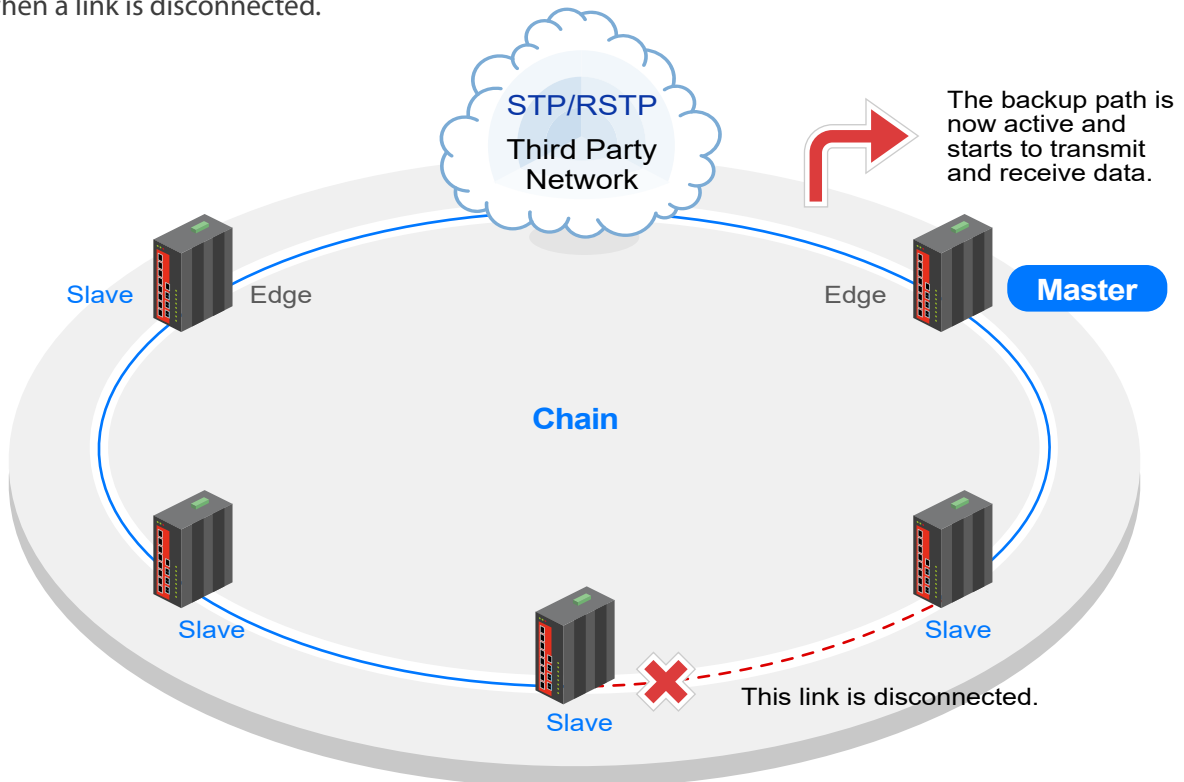

Figure 9. The change of backup path when a link is disconnected in a ring (u-Chain type)

• **Sub-Ring type**

Unlike u-Ring and u-Chain type that can be used individually in a closed and open ring topology, Sub-Ring type must be used either with u-Ring or u-Chain type. In a Sub-Ring topology, the maximum number of devices supported is 250. Using Sub-Ring type allows users to have more flexibility in planning their network topology. For example, in the following Figure 10, it shows a Sub-Ring is connected to a major ring to establish a bigger and more complex ring topology.

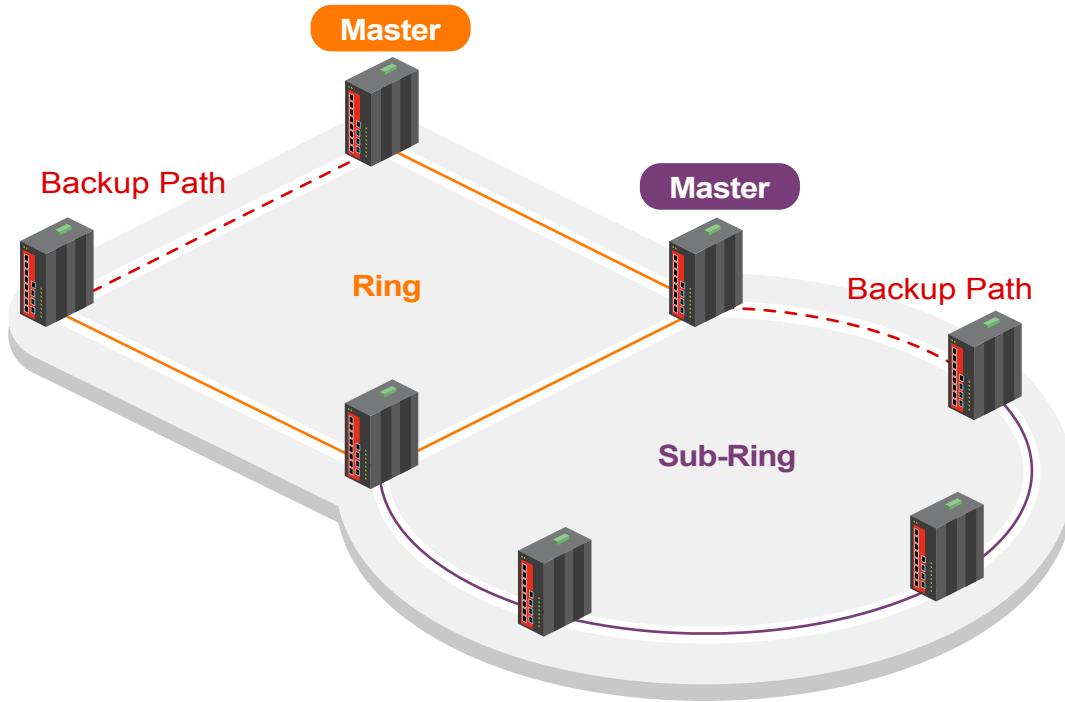

Figure 10. A major ring and a Sub-Ring topology

It is important to know that the minimum number of switches engaging in Sub-Ring topology is 3. If you have 2 switches, please restructure your ring topology to make it work in Sub-Ring topology. See Figure 11 for the right and wrong Sub-Ring topology illustration.

Ring Configuration Type

- u-Ring
- Sub-Ring
- ▲ u-Chain

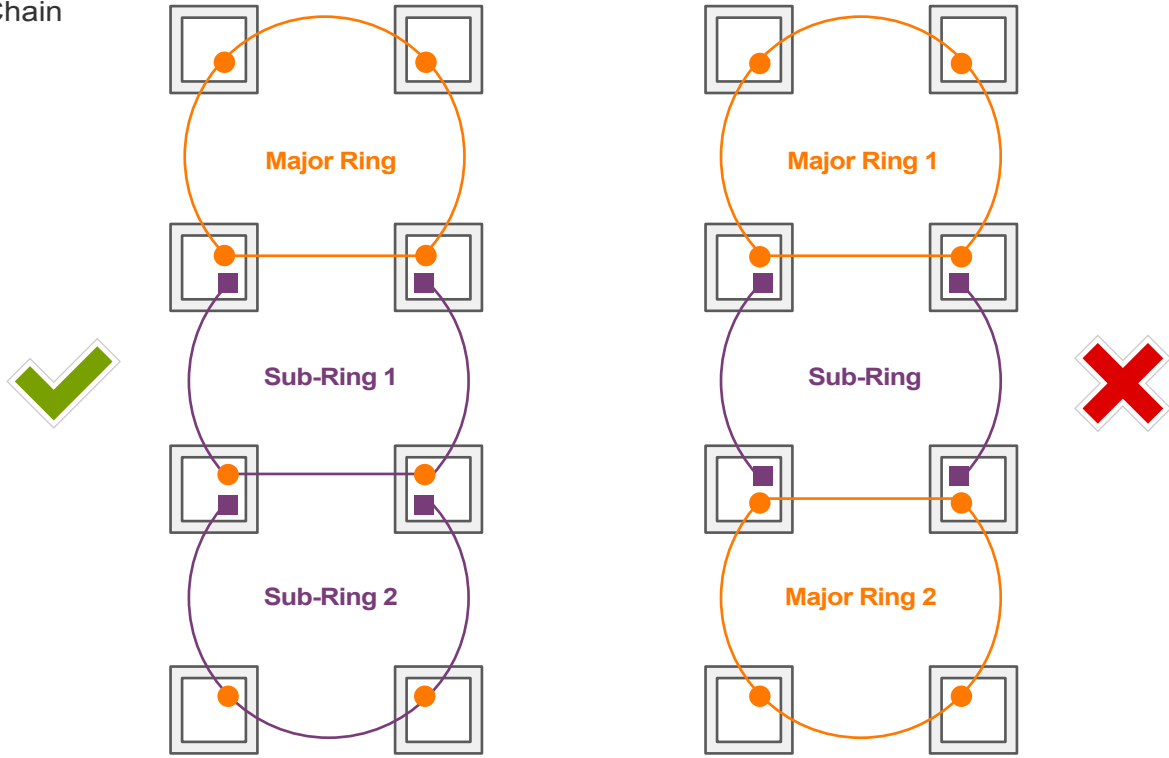

Figure 11. Right and wrong ring topology

Similar to u-Ring and u-Chain type, users can manually select the Master in Sub-Ring. If the Master is not selected manually, u-Ring redundancy protocol automatically selects the Master based on the MAC address of the participating switches. The bigger the MAC address is the higher possibility to become the Master. Once the Master is determined, the port with the highest port number is blocked and temporarily acts as the backup path. If the Master falls on the Sub-Ring device, the configured port is blocked and acts as the temporary backup path until a faulty link is detected in Sub-Ring. Please note that the participating devices that are not selected as the Master are in Slave roles. See Figure 12 for an illustration.

Ring Configuration Type

- u-Ring
- Sub-Ring
- ▲ u-Chain

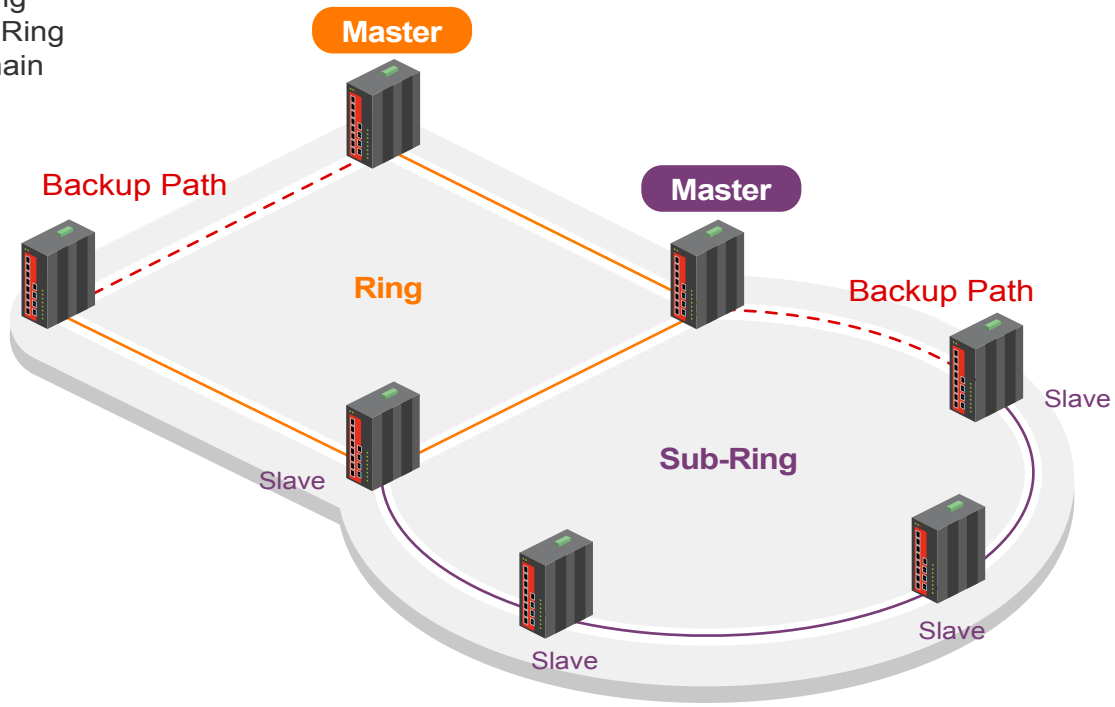

Figure 12. Determining the backup path (Sub-Ring type)

In the event of link disconnection in the Sub-Ring, the backup path will become active instantly in 10ms in a ring to transmit and receive data so as to ensure continuous connectivity. On the other hand, the broken link will now act as the backup path until the problem of faulty link is solved. Figure 13 illustrates the change of backup path when a link is disconnected.

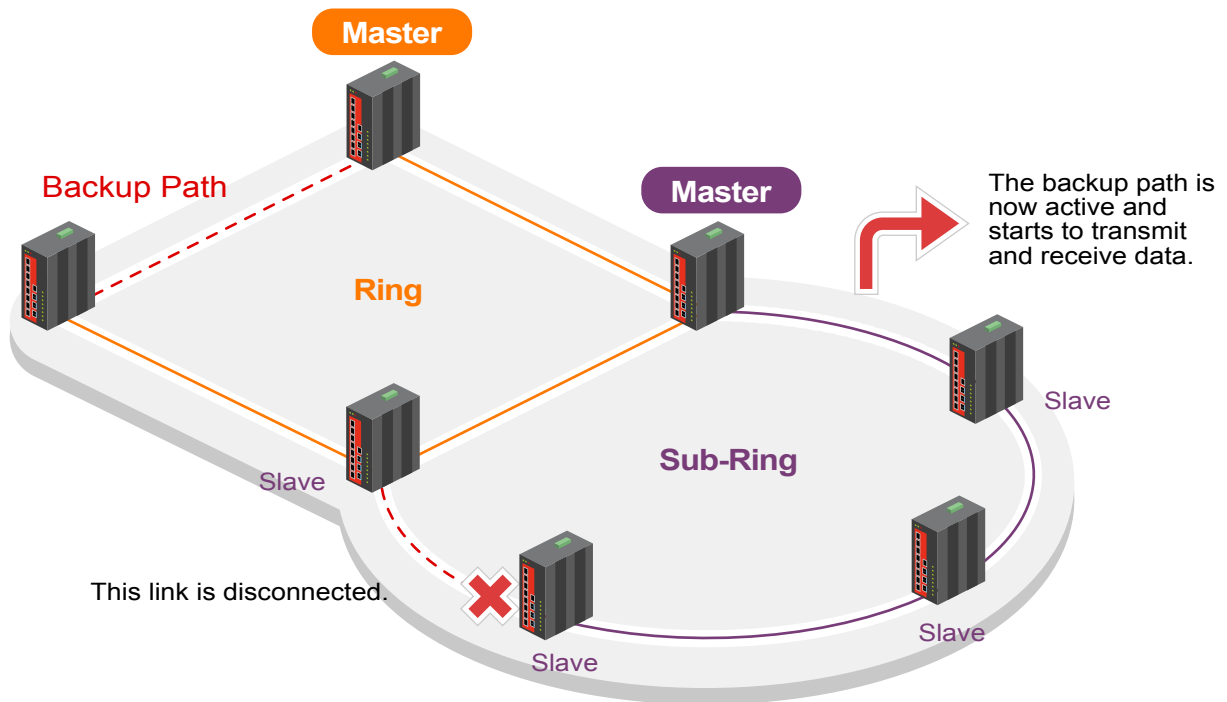

Figure 13. The change of backup path when a link is disconnected in a ring (Sub-Ring type)

4. Advanced and Complex Applications

As mentioned, u-Ring redundancy protocol supports three ring types, namely u-Ring, u-Chain, and Sub-Ring type that are intended to fulfill most of ring topologies in practice. This section provides samples of advanced and more complex applications that make the most of three u-Ring types. These samples are used here for reference. Ring combinations that are not included here are also supported as long as you have right ring topology and cabling since u-Ring redundancy protocol is designed as flexibly as possible to satisfy demands of most networking environments.

• Multiple Rings

u-Ring type is used in a closed ring topology and can be used in the topology like the one in Figure 14. Apart from the two-ring topology, u-Ring type can also support multiple rings topology like the one shown in Figure 15-1. Of course, you can use both topologies together to form another one if your networking environment requires the one in this manner (Figure 15-2).

Ring Configuration Type

- u-Ring
- Sub-Ring
- ▲ u-Chain

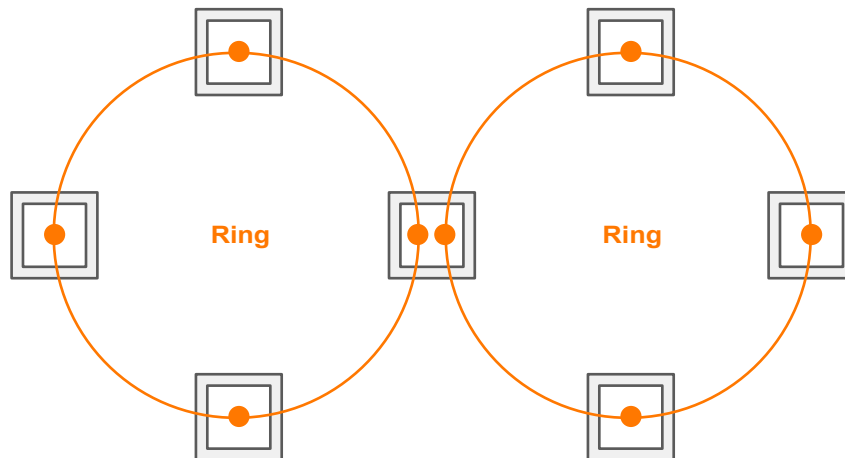

Figure 14. Two rings topology

Ring Configuration Type

- u-Ring
- Sub-Ring
- ▲ u-Chain

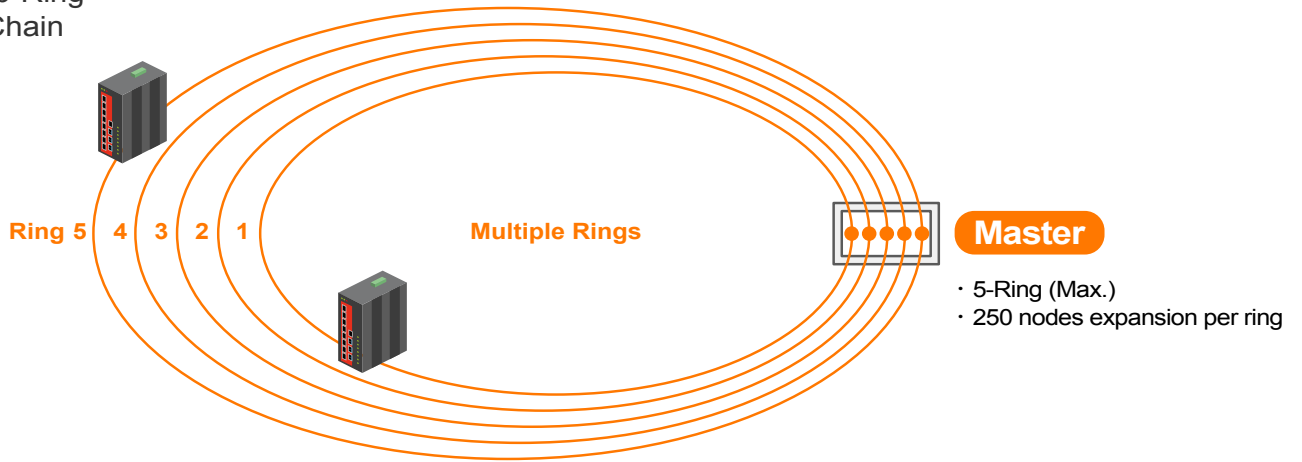

Figure 15-1. Multiple Rings

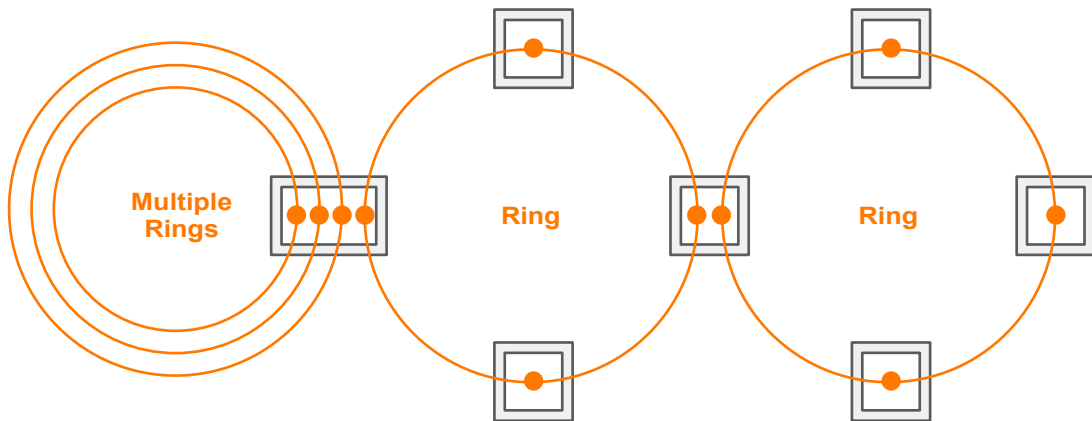

Figure 15-2. Multiple Rings

• **Combination of u-Chain type & u-Ring type**

For more advanced and complex applications, users can combine two u-Ring types or even three types in their own topology. In the following Figure 16, it shows a ring is used together with a chain.

Ring Configuration Type

- u-Ring
- Sub-Ring
- ▲ u-Chain

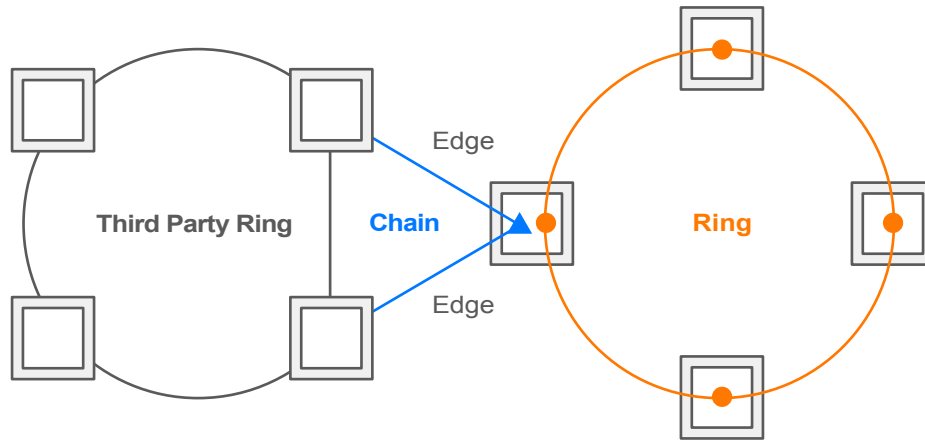

Figure 16. Combination of a ring and a chain

• **Combination of u-Chain type and Sub-Ring type**

As mentioned before, Sub-Ring type must co-exist with u-Ring or u-Chain type to form a bigger and more complex topology. In this example, it shows the uses of u-Ring, u-Chain and Sub-Ring type to construct a chain and Sub-Ring topology.

Ring Configuration Type

- u-Ring
- Sub-Ring
- ▲ u-Chain

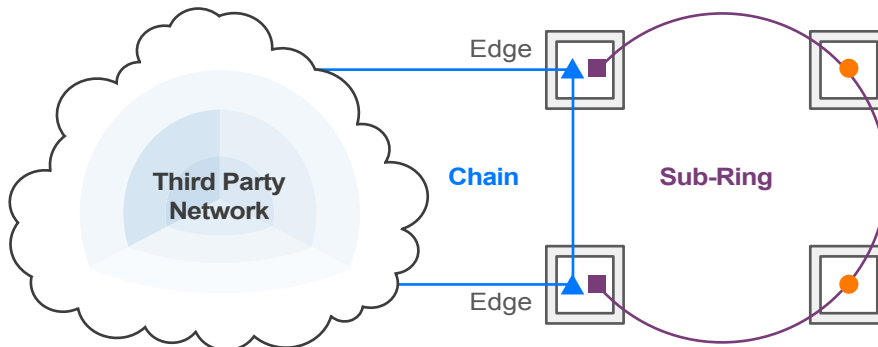

Figure 17. Combination of a chain and a Sub-Ring

• **Combination of u-Ring type and Sub-Ring type**

As mentioned before, Sub-Ring type must co-exist with u-Ring or u-Chain type to form a bigger and more complex topology. By using u-Ring type and Sub-Ring type, users can establish a wide variety of applications depending on the needs of actual scenarios. For more advanced topology examples, see figures provided below from Figure 18 to Figure 21.

Ring Configuration Type

- u-Ring
- Sub-Ring
- ▲ u-Chain

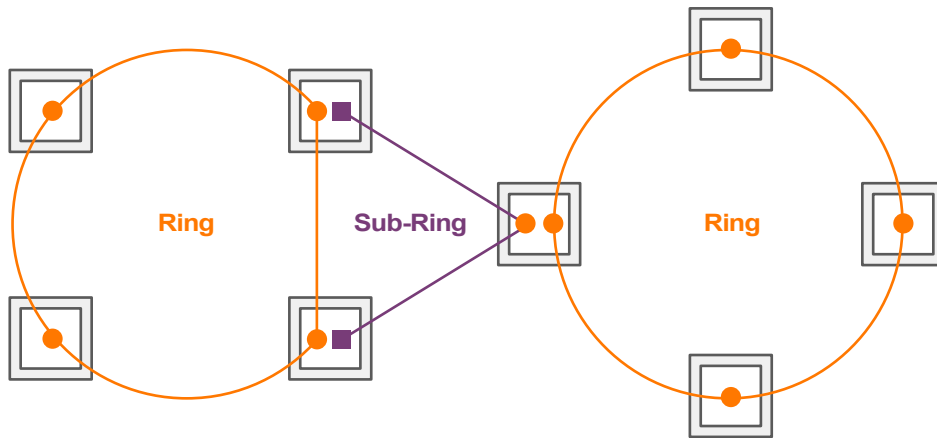

Figure 18. Combination of two rings and a Sub-Ring

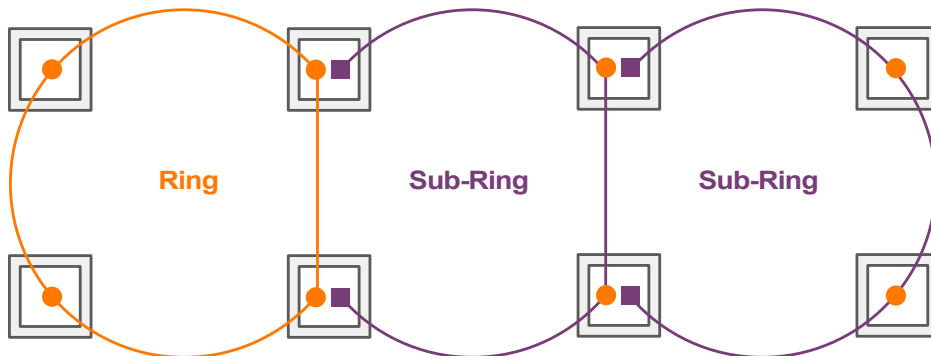

Figure 19-1. Combination of a ring and two Sub-Ring

Ring Configuration Type

- u-Ring
- Sub-Ring
- ▲ u-Chain

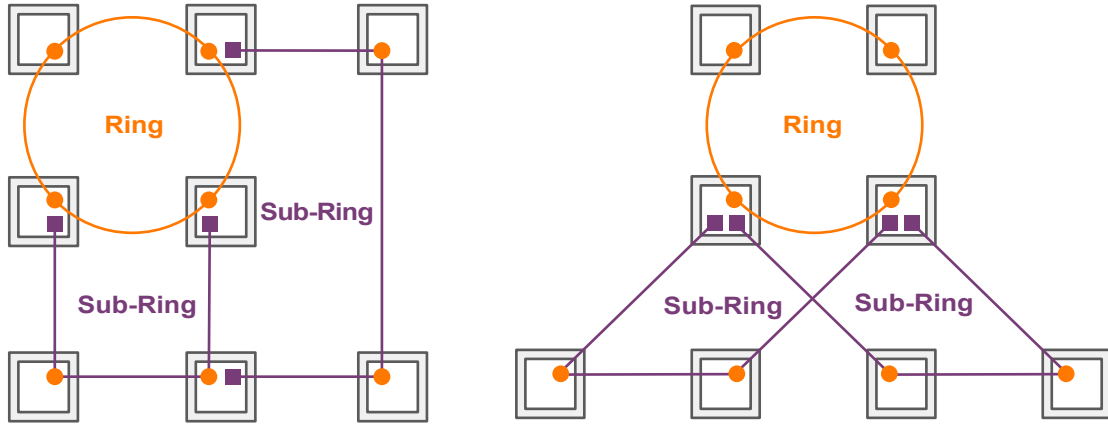

Figure 19-2. Combination of a ring and two Sub-Ring

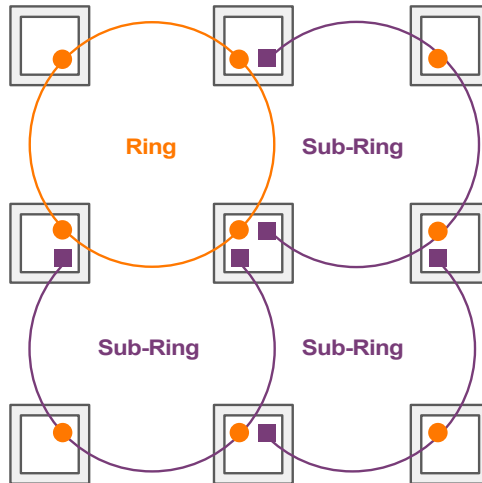

Figure 20. Combination of a ring and three Sub-Ring

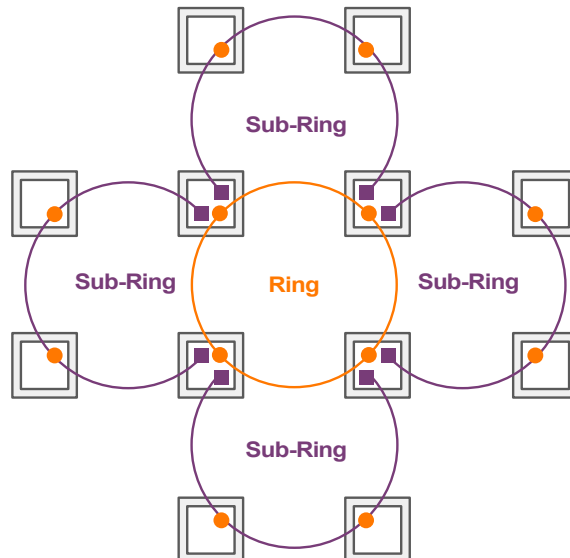

Figure 21. Combination of a ring and four Sub-Ring

5. u-Ring Recovery Time Performance Test

For networking devices used in mission-critical applications, the shorter recovery time means that the less possibility the network suffers from data loss when a link is abruptly disconnected. u-Ring redundancy protocol performs exceedingly well than spanning tree protocols and other proprietary ring protocols especially in its outstanding performance in fault recovery time. This is well supported by the lab test using the ring architecture. In this section, we provide the descriptions of recovery time performance test to further demonstrate that u-Ring is a perfect choice for applications that emphasize on reliability and scalability.

• Test design

The recovery time performance test was conducted in the lab environment where we have easy access to power sockets and testing equipments such as IXIA. The total number of u-Ring supported devices required is 250. These devices were used in the ring-type redundancy architecture as displayed in Figure 22 below.

Design Items	Descriptions
Redundancy Architecture	Ring
Number of devices Required (u-Ring supported)	250 (maximum)
Environment	Lab with testing equipment (IXIA, etc)
Number of test cases	25

Table 1. Descriptions of test design

The recovery time performance test was conducted in the lab environment where we have easy access to power sockets and testing equipments such as IXIA. The total number of u-Ring supported devices required is 250. These devices were used in the ring-type redundancy architecture as displayed in Figure 22 below.

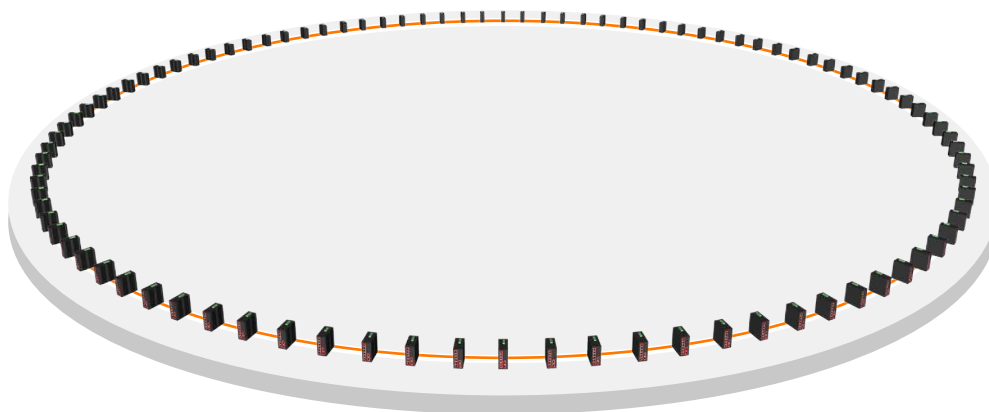

Figure 22. Ring-type architecture used in recovery time performance test

The recovery time performance test consists of 25 test cases. Each case uses the same redundancy architecture and is conducted in the same lab environment. However, each test case uses different number of devices. Initially, we started from the test case with 250 devices. Then, when implementing the next test case, we removed 10 devices from the ring and so on.

• Cabling devices

All devices participating in the performance test were ringed using fiber ports. Each device was connected with two (right & left) neighboring devices. When fiber cables were all installed correctly, LED indicators on each device's front panel were lit. While installing fiber cables, we intentionally left one cable uninstalled so as to avoid loops. After u-Ring instance was created correctly via Web interface on each device, this uninstalled fiber cable was connected. The Figure 23 below is the picture that was taken in the lab after devices were properly cabled in the lab.

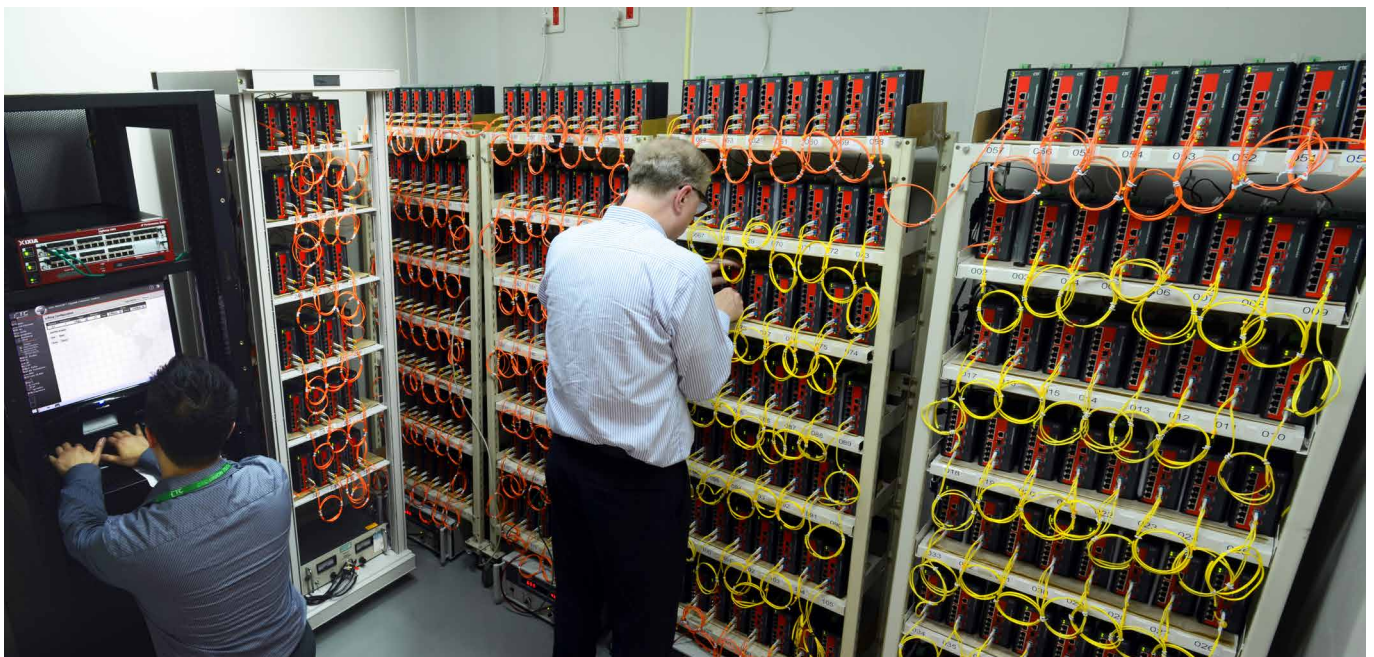

Figure 23. u-Ring recovery time performance test in the lab

• Web-based configurations

To enable u-Ring redundancy protocol, one u-Ring instance was created via Web interface on each device. For detailed descriptions on setting up the instance, please refer to the User Manual. Here, we provide screenshots of the configuration page (Figure 24) and status page from the Master device and Slave device's point of view (Figure 25 & Figure 26).

u-Ring Configuration

Delete	Instance	Type	Master	Port			
<input type="checkbox"/>	1	u-Ring	<input type="checkbox"/>	East	9 (Fiber1)	West	10 (Fiber2)

Figure 24. u-Ring configuration page

u-Ring Status

Instance	Type	Role	East Port			West Port			Healthy
			Number	State	Edge	Number	State	Edge	
1	u-Ring	Master	9 (Fiber1)	Forwarding	---	10 (Fiber2)	Blocking	---	

Figure 25. u-Ring status page of the Master device

u-Ring Status

Instance	Type	Role	East Port			West Port			Healthy
			Number	State	Edge	Number	State	Edge	
1	u-Ring	Slave	9 (Fiber1)	Forwarding	---	10 (Fiber2)	Forwarding	---	

Figure 26. u-Ring status page of the Slave device

• Lab implementation

The recovery time performance test contains 25 test cases. In each test case, test design, cabling and configuration methods are all the same except the number of devices used. We started from the test case with 250 devices first. Then, in the next test case, we removed 10 devices from participating devices and so forth. To obtain more reliable results, each test case was conducted five times and each time we randomly disconnected a different link.

• Test results

This performance test is intended to provide a convincing proof that u-Ring can recover rapidly in 10ms when a faulty link occurs in ring architecture. This lab performance test consists of 25 test cases. Each case was tested in the same lab environment with same cabling and configuration methods; however, each case used different number of devices in ring architecture. The recovery time test for each case was conducted five times. In order to get more precise results of recovery time, each time a different link was randomly disconnected. The following Table 2 displays average recovery time results of each case. From the table, it clearly shows that u-Ring redundancy protocol can recover from a faulty link in 10ms even in full-loaded (250 devices) ring environment. If fewer devices are used, the average recovery time can be shorter (around 8 ms).

Test Case #	Number of Devices used	Average Recovery Time (ms)	Test Case #	Number of Devices used	Average Recovery Time (ms)
1	250	8.160 ms	16	100	7.930 ms
2	240	8.151 ms	17	90	7.825 ms
3	230	8.082 ms	18	80	7.823 ms
4	220	8.077 ms	19	70	7.815 ms
5	210	8.067 ms	20	60	7.814 ms
6	200	8.066 ms	21	50	7.797 ms
7	190	8.042 ms	22	40	7.796 ms
8	180	7.993 ms	23	30	7.787 ms
9	170	7.996 ms	24	20	7.781 ms
10	160	7.994 ms	25	10	7.775 ms
11	150	7.964 ms			
12	140	7.935 ms			
13	130	7.916 ms			
14	120	7.905 ms			
15	110	7.931 ms			

Table 2. Results of u-Ring recovery time performance test

Summary

Responding to unplanned downtime strategically and rapidly, the proprietary u-Ring redundancy protocol is preferred than other redundancy mechanisms. u-Ring redundancy protocol especially for mission-critical industrial devices is better than standard STP protocols in a number of ways. First, using u-Ring redundancy protocol enables users to deploy their network topology in a flexible and scalable way. Different from STP and RSTP that support limited number of devices in STP system and have rather long convergence time, u-Ring redundancy protocol can support up to 250 devices in a u-Ring, u-Chain and Sub-Ring topology and is able to recover from a network fault in 10ms. This rapid recovery reduces the possibility of packet loss and provides always-on connectivity to prevent the disastrous consequences from happening. Next, u-Ring redundancy protocol not only supports basic ring topology like ring, chain, Sub-Ring but also can be used in advanced and complex topology by using more than two ring type combinations. Then, the configuration process of u-Ring redundancy protocol is simple and the determination of the Master and backup path is even automatic. For monitoring and maintenance purposes, the ring status can be viewed via Web interface or Smart View management system. All in all, these distinctive features not only help network engineers to establish fault-tolerant and stable networks, but also help the company to secure the success of a business.

• About CTC Union

CTC Union is committed to developing and manufacturing network communication products. Particularly, CTC Union focuses on fiber optical technologies, Ethernet technologies and the integration of broadband access technologies. A wide range of products is available from CTC Union including Industrial PoE switch & converter, Metro & FTTH Ethernet switch, xDSL Bridge/Router. Visit us at www.ctcu.com for more detailed information.

CTC UNION TECHNOLOGIES CO., LTD.

8F, No.60, Zhouzi St. Neihu, Taipei 114, Taiwan
 TEL : +886 2 2659-1021 FAX : +886 2 2659-0237
 sales@ctcu.com www.ctcu.com